

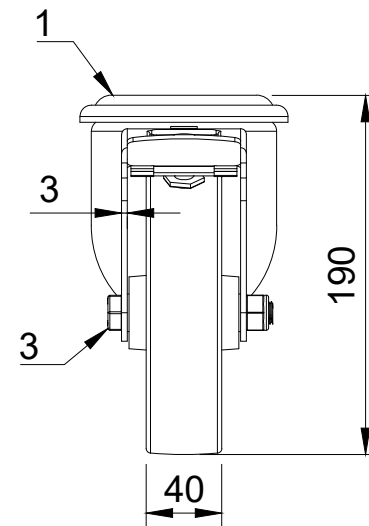

ITEM NO.	PART NUMBER	QTY
1	BZMM150ASBH12SWB	1
2	BZH150WNP	1
3	AXLE KIT	
	TUBEM20X60	1
	HEXBOLTM12X80Z8.8	1
	NYLOCM12Z	1



UNLESS OTHERWISE SPECIFIED DIMENSIONS ARE IN MILLIMETRES Unspecified Tolerances Machining ± 0.25mm Fabrication ± 1mm	DRAWING DISCLAIMER COPYRIGHT OF THIS DRAWING IS RESERVED BY BIL GROUP LTD. IT IS NOT REPRODUCED, COPIED, OR DISCLOSED TO A THIRD PARTY EITHER WHOLLY OR IN PART WITHOUT THE CONSENT IN WRITING OF BIL GROUP LTD	NAME Matt	DATE 13/03/24		BIL Group Ltd Porte Marsh Road Calne, Wiltshire, SN11 9BW United Kingdom Tel +44 (0)1249 822 222 www.bilgroup.co.uk	
		DRAWN BY Matt	DATE 13/03/24		DWG NO. BZMM150NPBH12SWB	REV 1
		APPROVED BY Kevin	DATE 13/03/24	SCALE 1:4	BZMM150NPBH12SWB SHEET 1 OF 1	
		WEIGHT 2.213kg				