

ITEM NO.	PART NUMBER	QTY
1	ZINC PLATED PRESSED STEEL BRACKET	1
2	NYLON WHEEL	1
3	AXLEKIT	1

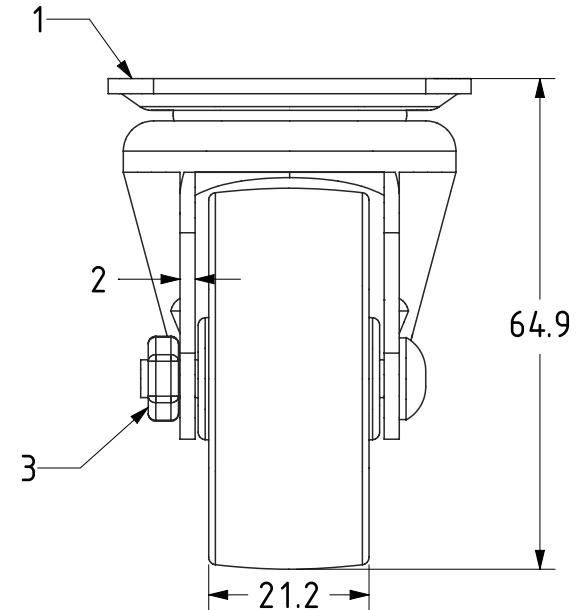

UNLESS OTHERWISE SPECIFIED DIMENSIONS ARE IN MILLIMETRES

Unspecified Tolerances  
Machining ± 0.25mm  
Fabrication ± 1mm

DRAWING DISCLAIMER

COPYRIGHT OF THIS DRAWING IS RESERVED BY BIL GROUP LTD. IT IS ISSUED ON CONDITION THAT IT IS NOT REPRODUCED, COPIED, OR DISCLOSED TO A THIRD PARTY EITHER WHOLLY OR IN PART WITHOUT THE CONSENT IN WRITING OF BIL GROUP LTD.

	NAME	DATE
DRAWN	Matt	28/06/21
APPROVED BY	Kevin	28/06/21
SCALE	1:1	
WEIGHT	0.164kg	

 <p>BIL Group Ltd, Porte Marsh Road, Calne Wiltshire, SN11 9BW, United Kingdom Tel +44 (0)1249 822 222 Fax: +44 (0)1249 822 300 www.bilgroup.co.uk</p>	DWG NO.	BZH50NY	REV	1
	BZH50NY		SHEET 1 OF 1	