

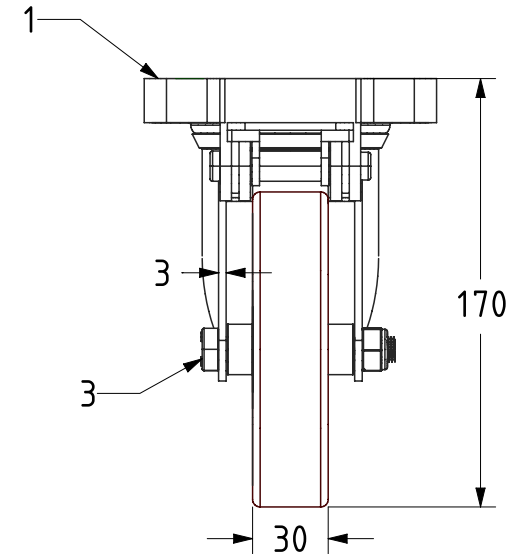

ITEM NO.	PART NUMBER	QTY
1	BZEH125ASFPSWBLP	1
2	BZH125WPTBJM15	1
3	AXLE KIT	
	TH15X10X10	2
	HEXBOLTM10X70Z8.8	1
	NYLOCM10Z	1



<p>UNLESS OTHERWISE SPECIFIED DIMENSIONS ARE IN MILLIMETRES</p> <p>Unspecified Tolerances Machining ± 0.25mm Fabrication ± 1mm</p>	<p>DRAWING DISCLAIMER</p> <p>COPYRIGHT OF THIS DRAWING IS RESERVED BY BIL GROUP LTD. IT IS ISSUED ON CONDITION THAT IT IS NOT REPRODUCED, COPIED, OR DISCLOSED TO A THIRD PARTY EITHER WHOLLY OR IN PART WITHOUT THE CONSENT IN WRITING OF BIL GROUP LTD.</p>		NAME	DATE	 <p>BIL Group Ltd, Porte Marsh Road, Calne, Wiltshire, SN11 9BW, United Kingdom Tel +44 (0)1249 822 222 www.bilgroup.co.uk</p>		
		DRAWN	Matt	25/01/23			
		APPROVED BY	Kevin	25/01/23	DWG NO.	BZEH125PTBJFPSWB	REV 1
		SCALE	1:3		BZEH125PTBJFPSWB		SHEET 1 OF 1
		WEIGHT	1.796kg				