

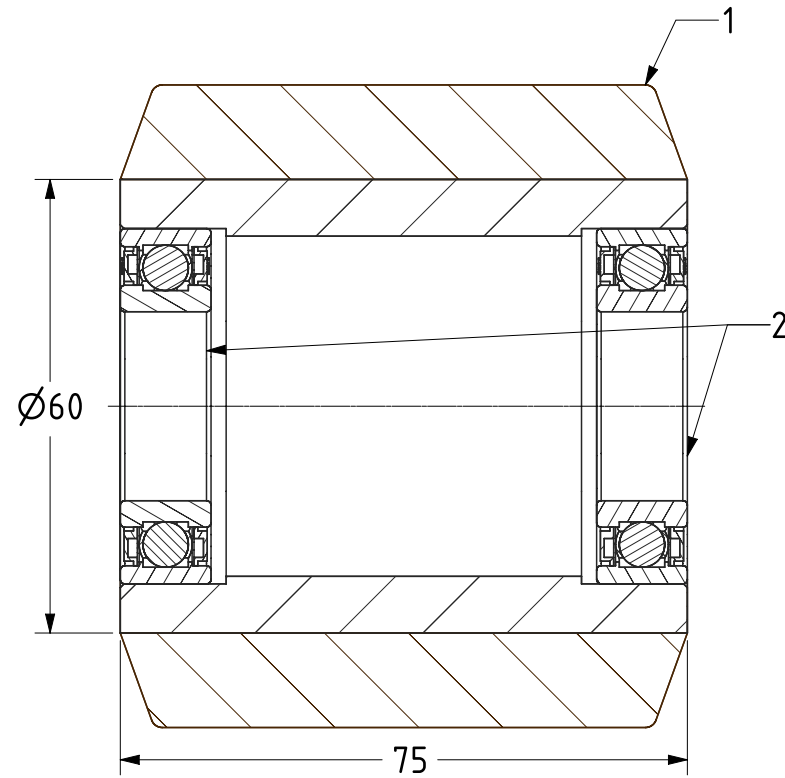

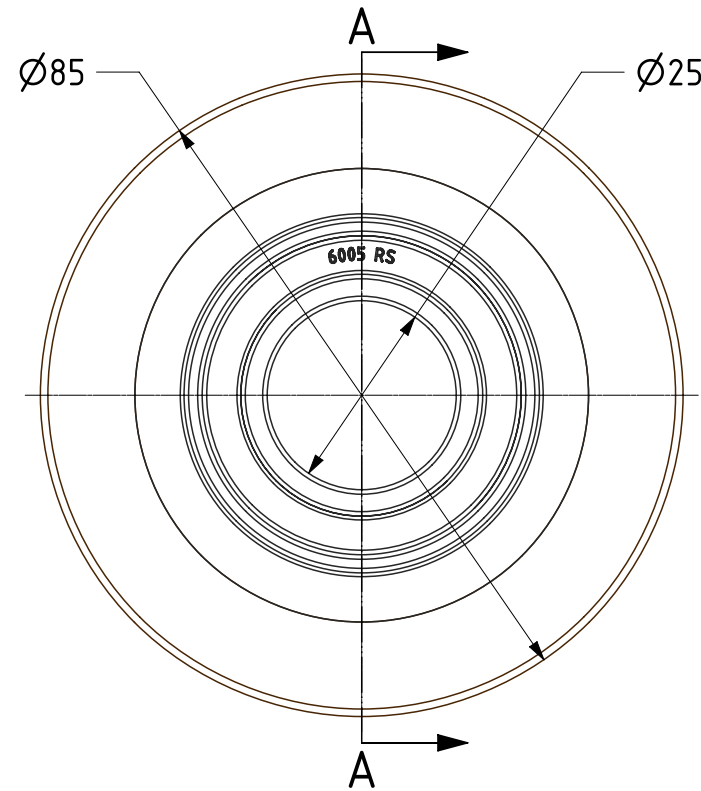

ITEM NO.	PART NUMBER	QTY
1	BZH8575WPTBJ	1
2	BEARING6005	2



SECTION A-A



UNLESS OTHERWISE SPECIFIED DIMENSIONS ARE IN MILLIMETRES  Unspecified Tolerances Machining ± 0.25mm Fabrication ± 1mm	DRAWING DISCLAIMER  COPYRIGHT OF THIS DRAWING IS RESERVED BY BIL GROUP LTD. IT IS ISSUED ON CONDITION THAT IT IS NOT REPRODUCED, COPIED, OR DISCLOSED TO A THIRD PARTY EITHER WHOLLY OR IN PART WITHOUT THE CONSENT IN WRITING OF BIL GROUP LTD.		NAME	DATE	 BIL Group Ltd, Porte Marsh Road, Calne Wiltshire, SN11 9BW, United Kingdom Tel +44 (0)1249 822 222 Fax: +44 (0)1249 822 300 www.bilgroup.co.uk		
		DRAWN	Matt	04/05/22			
		APPROVED BY	Kevin	04/05/22			
		SCALE	1:1				
		WEIGHT	1.099kg				
				DWG NO.	BZH8575WPTBJM25	REV	1
				BZH8575WPTBJM25		SHEET 1 OF 1	