

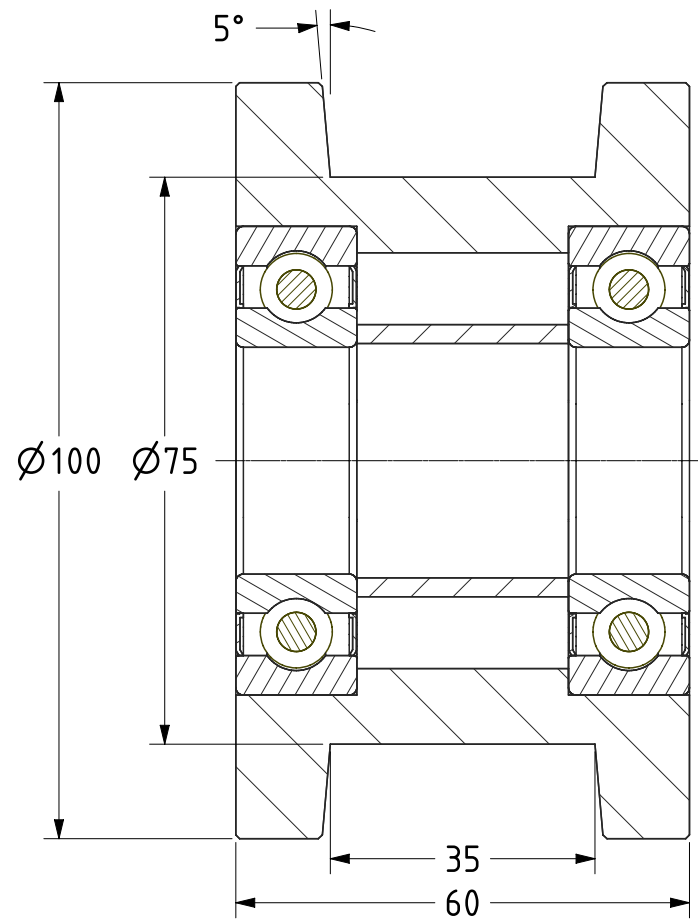

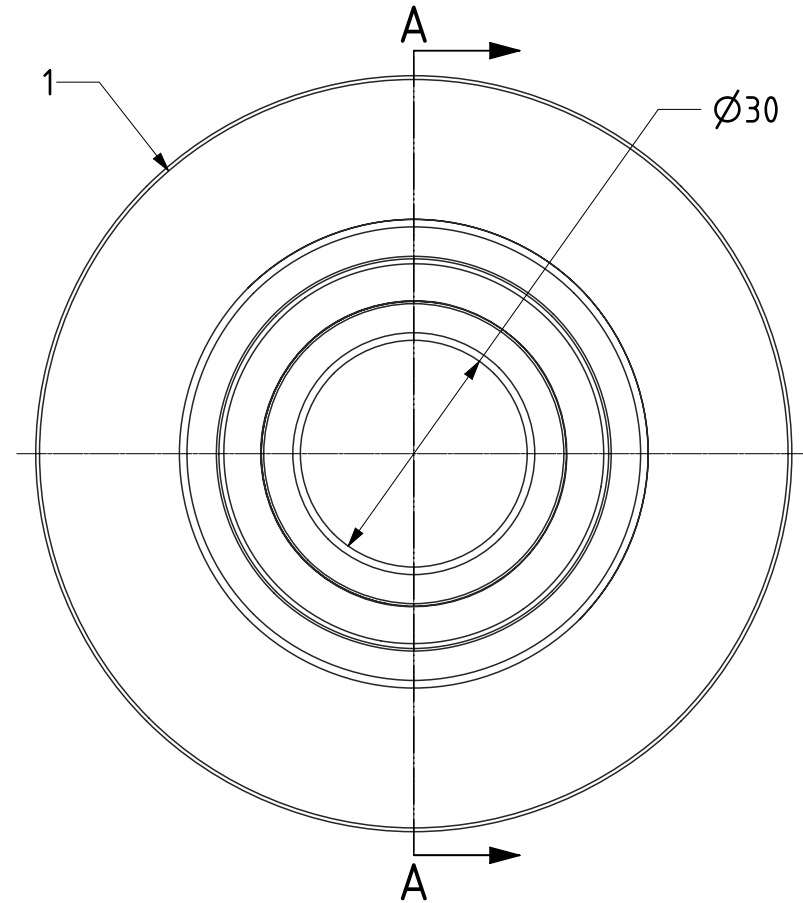

ITEM NO.	PART NUMBER	QTY
1	75WSTDFBJ30	1



SECTION A-A



UNLESS OTHERWISE SPECIFIED DIMENSIONS ARE IN MILLIMETRES Unspecified Tolerances Machining $\pm 0.25\text{mm}$ Fabrication $\pm 1\text{mm}$	DRAWING DISCLAIMER COPYRIGHT OF THIS DRAWING IS RESERVED BY BIL GROUP LTD. IT IS ISSUED ON CONDITION THAT IT IS NOT REPRODUCED, COPIED, OR DISCLOSED TO A THIRD PARTY EITHER WHOLLY OR IN PART WITHOUT THE CONSENT IN WRITING OF BIL GROUP LTD.		NAME	DATE	 BIL Group Ltd, Porte Marsh Road, Calne Wiltshire, SN11 9BW, United Kingdom Tel +44 (0)1249 822 222 Fax: +44 (0)1249 822 300 www.bilgroup.co.uk
		DRAWN	Matt	23/08/22	
		APPROVED BY	Kevin	23/08/22	
		SCALE	1:1		
		WEIGHT			
		DWG NO.	75WSTDFBJ30	REV	1
		75WSTDFBJ30		SHEET 1 OF 1	