

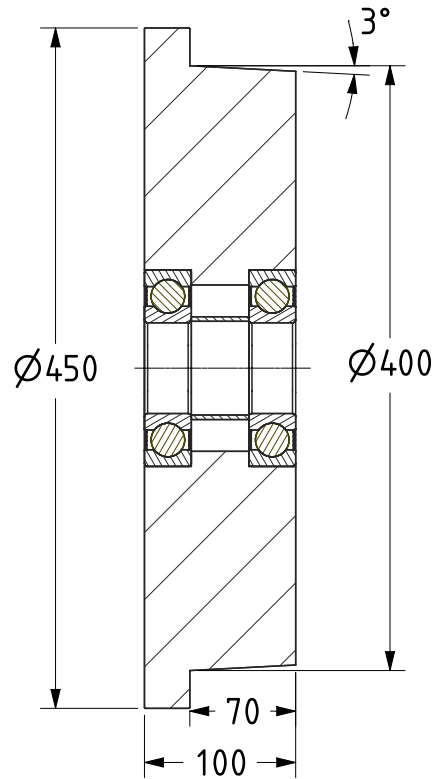

ITEM NO.	PART NUMBER	QTY
1	400WMSSFBJM60	1

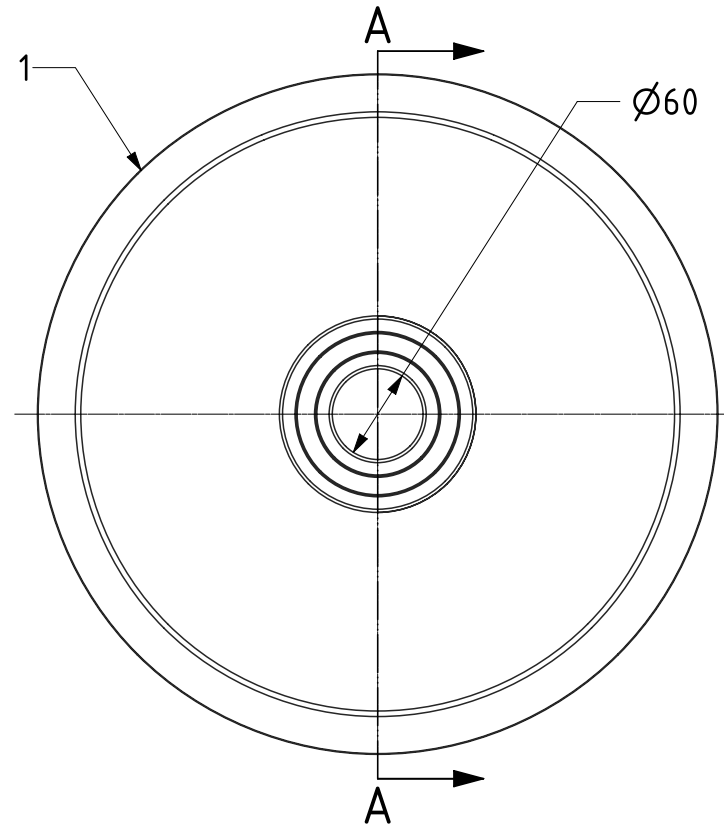

SECTION A-A



UNLESS OTHERWISE SPECIFIED DIMENSIONS ARE IN MILLIMETRES

Unspecified Tolerances  
Machining  $\pm 0.25\text{mm}$   
Fabrication  $\pm 1\text{mm}$

DRAWING DISCLAIMER

COPYRIGHT OF THIS DRAWING IS RESERVED BY BIL GROUP LTD. IT IS ISSUED ON CONDITION THAT IT IS NOT REPRODUCED, COPIED, OR DISCLOSED TO A THIRD PARTY EITHER WHOLLY OR IN PART WITHOUT THE CONSENT IN WRITING OF BIL GROUP LTD.

	NAME	DATE
DRAWN	Matt	18/08/22
APPROVED BY	Kevin	18/08/22
SCALE	1:5	
WEIGHT		

	BIL Group Ltd, Porte Marsh Road, Calne Wiltshire, SN11 9BW, United Kingdom Tel +44 (0)1249 822 222 Fax: +44 (0)1249 822 300 www.bilgroup.co.uk	
	DWG NO. 400WMSSFBJM60	REV 1
400WMSSFBJM60		SHEET 1 OF 1