

ITEM NO.	PART NUMBER	QTY
1	FLANGED NYLON WHEEL	1
2	BEARING6204ZZ	2
3	BEARING SPACER	1

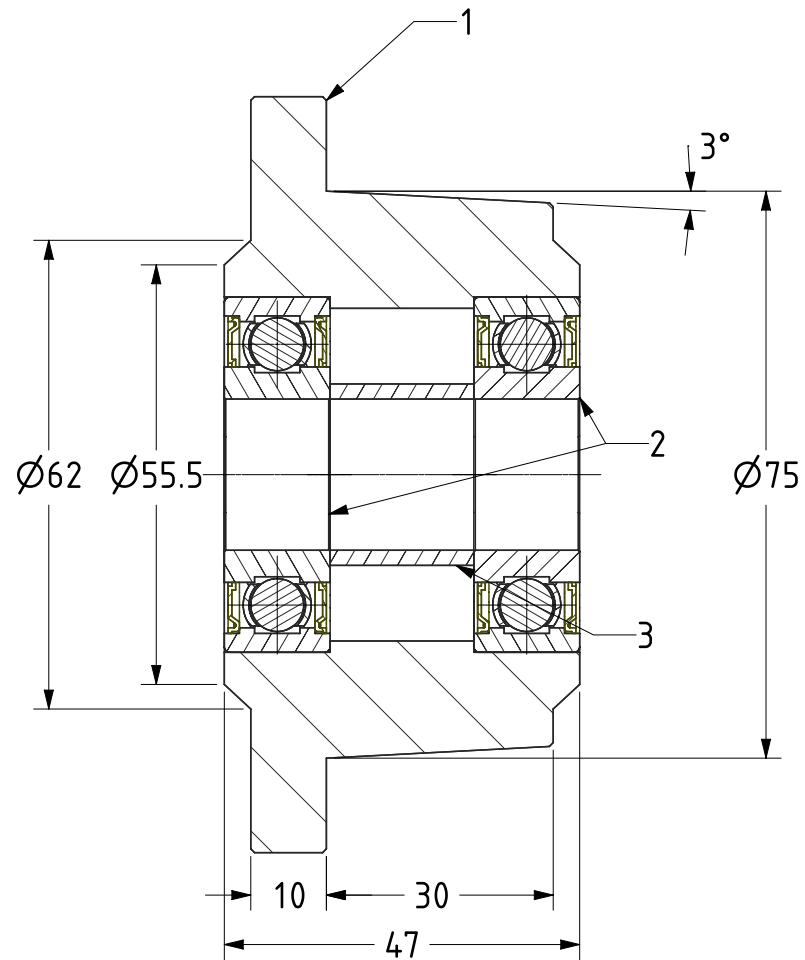

SECTION A-A

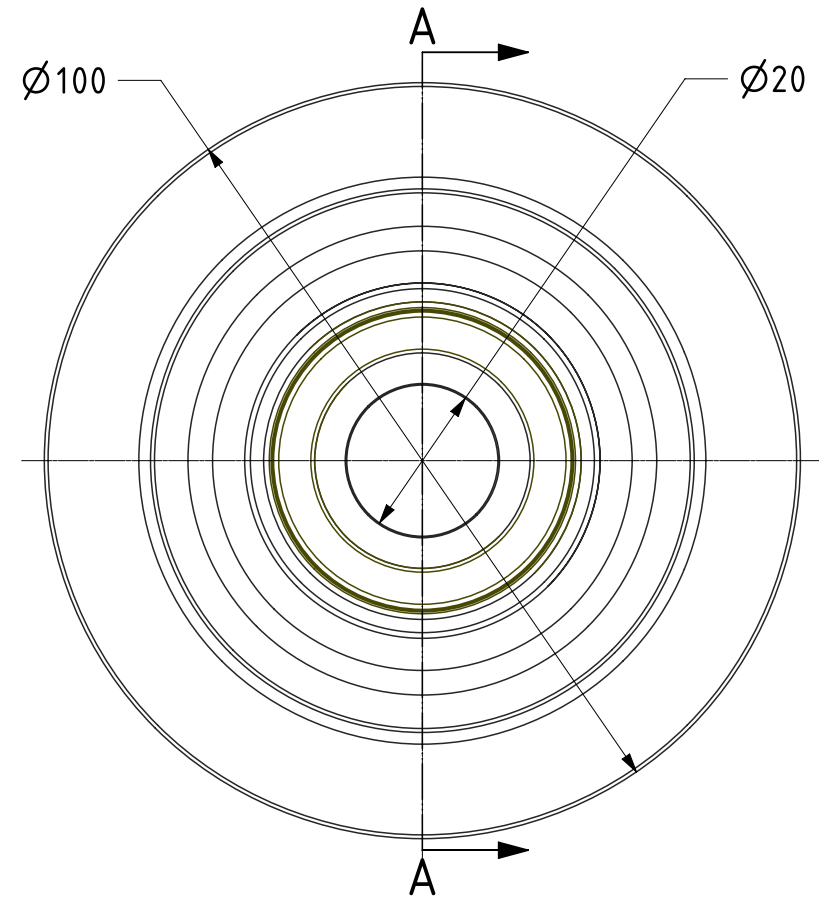

UNLESS OTHERWISE SPECIFIED DIMENSIONS ARE IN MILLIMETRES

Unspecified Tolerances
Machining $\pm 0.25\text{mm}$
Fabrication $\pm 1\text{mm}$

DRAWING DISCLAIMER

COPYRIGHT OF THIS DRAWING IS RESERVED BY BIL GROUP LTD. IT IS ISSUED ON CONDITION THAT IT IS NOT REPRODUCED, COPIED, OR DISCLOSED TO A THIRD PARTY EITHER WHOLLY OR IN PART WITHOUT THE CONSENT IN WRITING OF BIL GROUP LTD.

	NAME	DATE
DRAWN	Matt	02/11/21
APPROVED BY	Kevin	02/11/21
SCALE	1:1	
WEIGHT	0.385kg	



BIL Group Ltd, Porte Marsh Road, Calne
Wiltshire, SN11 9BW, United Kingdom
Tel +44 (0)1249 822 222 Fax: +44 (0)1249 822 300
www.bilgroup.co.uk

DWG NO.	BZH75WNYSFBJM20	REV	1
BZH75WNYSFBJM20		SHEET 1 OF 1	