

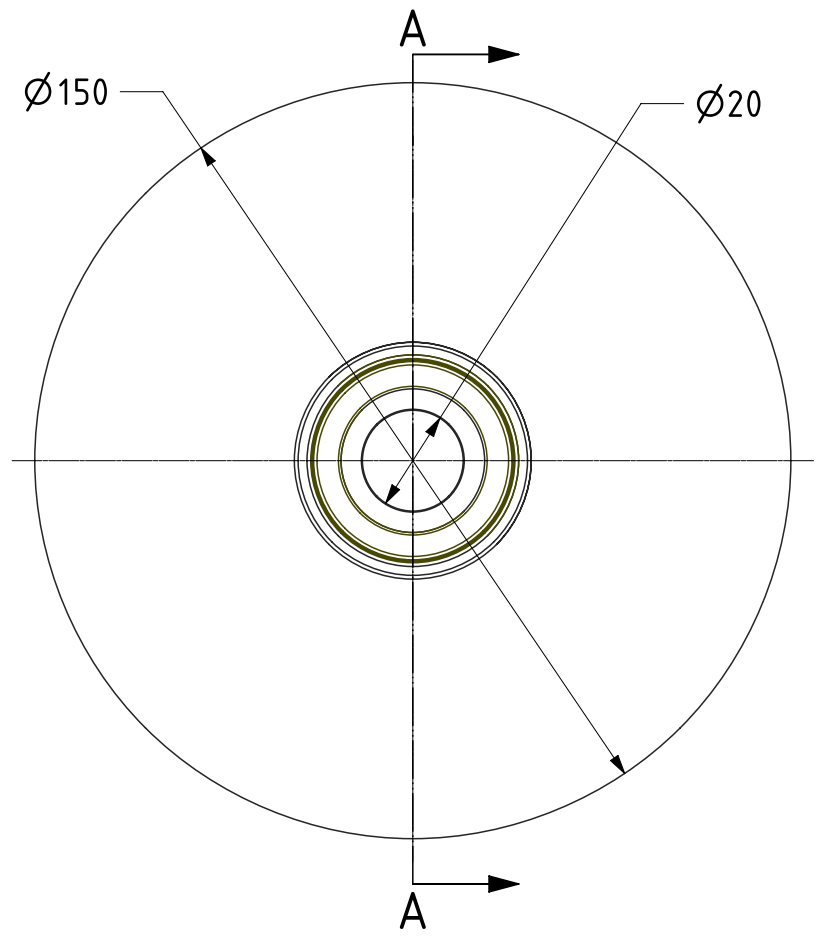

ITEM NO.	PART NUMBER	QTY
1	CAST NYLON V GROOVE WHEEL	1
2	BEARING6204ZZ	2
3	BEARING SPACER	1

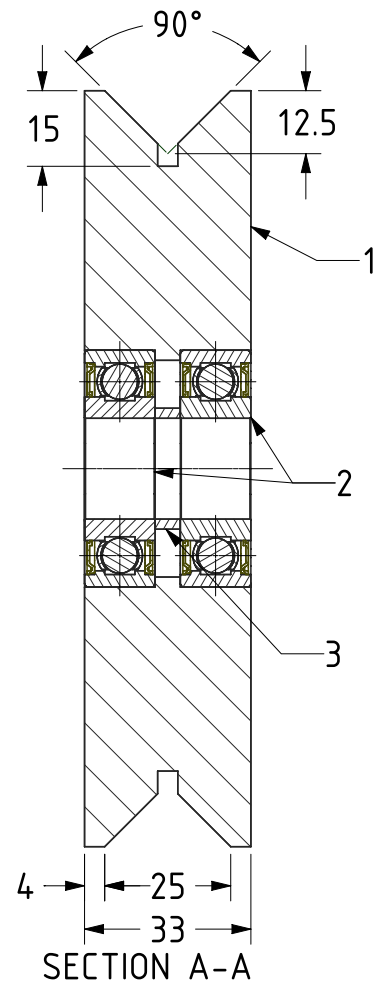

UNLESS OTHERWISE SPECIFIED DIMENSIONS ARE IN MILLIMETRES

Unspecified Tolerances
Machining ± 0.25mm
Fabrication ± 1mm

DRAWING DISCLAIMER

COPYRIGHT OF THIS DRAWING IS RESERVED BY BIL GROUP LTD. IT IS ISSUED ON CONDITION THAT IT IS NOT REPRODUCED, COPIED, OR DISCLOSED TO A THIRD PARTY EITHER WHOLLY OR IN PART WITHOUT THE CONSENT IN WRITING OF BIL GROUP LTD.

	NAME	DATE
DRAWN	Matt	03/11/21
APPROVED BY	Kevin	03/11/21
SCALE	2:3	
WEIGHT	0.732kg	



BIL Group Ltd, Porte Marsh Road, Calne
Wiltshire, SN11 9BW, United Kingdom
Tel +44 (0)1249 822 222 Fax: +44 (0)1249 822 300
www.bilgroup.co.uk

DWG NO.	BZH150WNYVBJM20	REV	1
BZH150WNYVBJM20		SHEET 1 OF 1	