

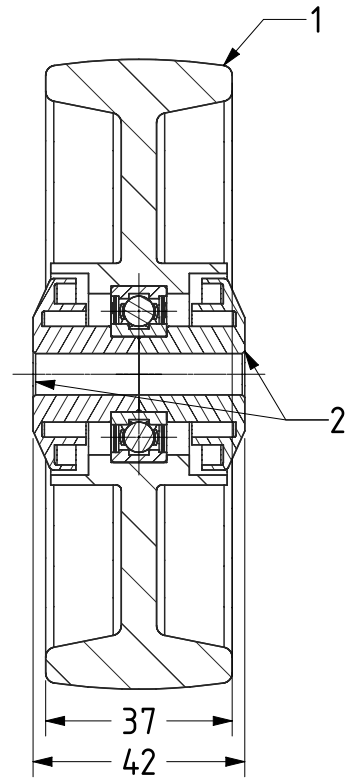

ITEM NO.	PART NUMBER	QTY
1	BZMM125WNYBJ	1
2	HUBCAPM8X42	2

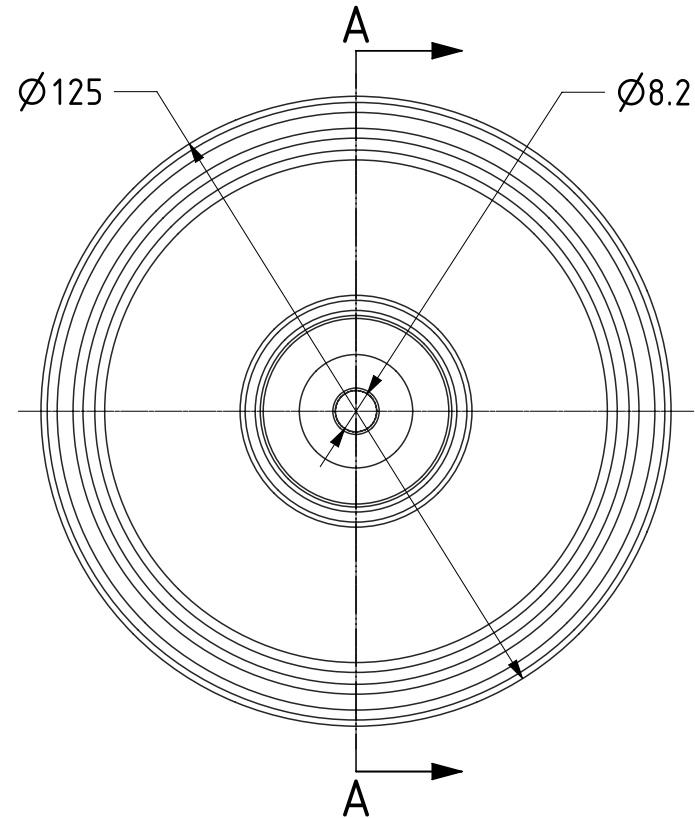

SECTION A-A



UNLESS OTHERWISE SPECIFIED DIMENSIONS ARE IN MILLIMETRES

Unspecified Tolerances
Machining $\pm 0.25\text{mm}$
Fabrication $\pm 1\text{mm}$

DRAWING DISCLAIMER

COPYRIGHT OF THIS DRAWING IS RESERVED BY BIL GROUP LTD. IT IS ISSUED ON CONDITION THAT IT IS NOT REPRODUCED, COPIED, OR DISCLOSED TO A THIRD PARTY EITHER WHOLLY OR IN PART WITHOUT THE CONSENT IN WRITING OF BIL GROUP LTD.

	NAME	DATE
DRAWN	Matt	20/10/21
APPROVED BY	Kevin	20/10/21
SCALE	2:3	
WEIGHT	0.252kg	



BIL Group Ltd, Porte Marsh Road, Calne
Wiltshire, SN11 9BW, United Kingdom
Tel +44 (0)1249 822 222 Fax: +44 (0)1249 822 300
www.bilgroup.co.uk

DWG NO.	BZMM125WNYBJM8	REV	1
BZMM125WNYBJM8		SHEET 1 OF 1	