

ITEM NO.	PART NUMBER	QTY
1	BZM125ASBH12	1
2	BZM125WGRECBJM10	1
3	AXLE KIT	
	TUBEM10X37	1
	BOLTBZM8MM	1
	NYLOCM8Z	1

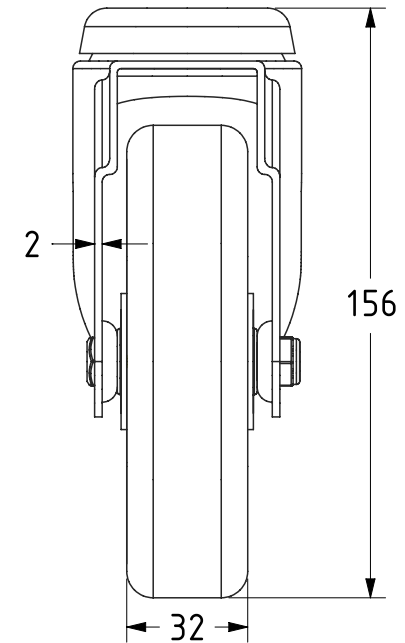

UNLESS OTHERWISE SPECIFIED DIMENSIONS ARE IN MILLIMETRES

Unspecified Tolerances
Machining $\pm 0.25\text{mm}$
Fabrication $\pm 1\text{mm}$

DRAWING DISCLAIMER

COPYRIGHT OF THIS DRAWING IS RESERVED BY BIL GROUP LTD. IT IS ISSUED ON CONDITION THAT IT IS NOT REPRODUCED, COPIED, OR DISCLOSED TO A THIRD PARTY EITHER WHOLLY OR IN PART WITHOUT THE CONSENT IN WRITING OF BIL GROUP LTD.

	NAME	DATE
DRAWN	Matt	26/06/23
APPROVED BY	Kevin	26/06/23
SCALE	1:2	
WEIGHT	0.633kg	

BIL Group Ltd,
Porte Marsh Road,
Calne, Wiltshire, SN11 9BW,
United Kingdom
Tel +44 (0)1249 822 222
www.bilgroup.co.uk

DWG NO. BZM125GRECBJBH12	REV 1
BZM125GRECBJBH12	SHEET 1 OF 1