

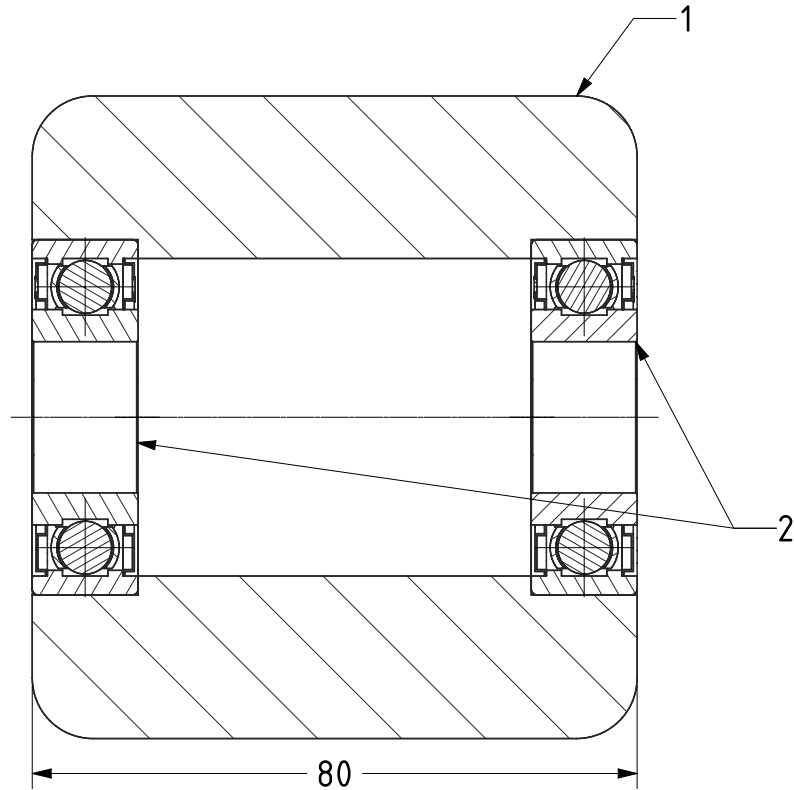

| ITEM NO. | PART NUMBER | QTY |
|----------|--------------|-----|
| 1 | BZH8580WNYBJ | 1 |
| 2 | BEARING6204 | 2 |

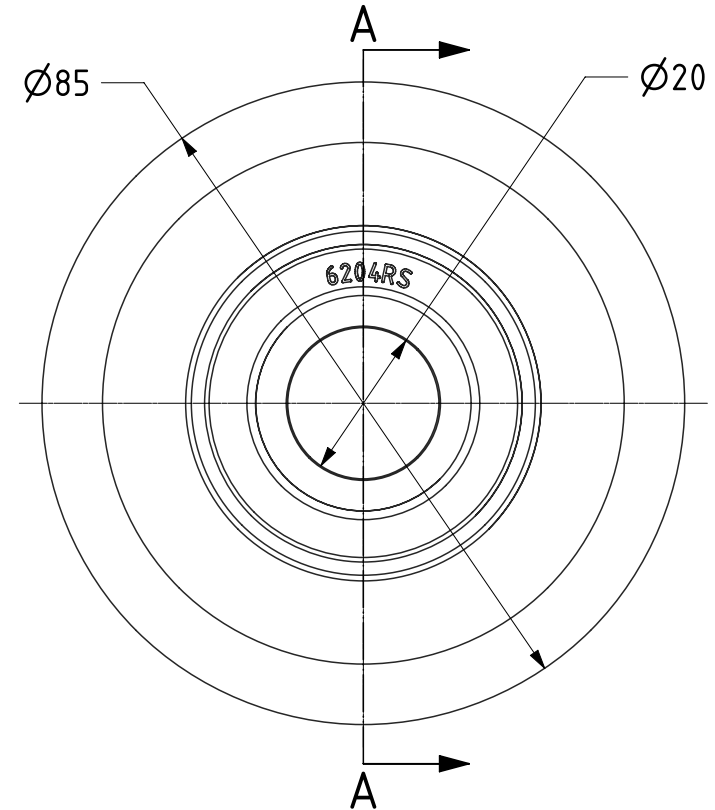

SECTION A-A



UNLESS OTHERWISE SPECIFIED DIMENSIONS ARE IN MILLIMETRES

Unspecified Tolerances
Machining $\pm 0.25\text{mm}$
Fabrication $\pm 1\text{mm}$

DRAWING DISCLAIMER

COPYRIGHT OF THIS DRAWING IS RESERVED BY BIL GROUP LTD. IT IS ISSUED ON CONDITION THAT IT IS NOT REPRODUCED, COPIED, OR DISCLOSED TO A THIRD PARTY EITHER WHOLLY OR IN PART WITHOUT THE CONSENT IN WRITING OF BIL GROUP LTD.

| | NAME | DATE |
|-------------|---------|----------|
| DRAWN | Matt | 28/10/21 |
| APPROVED BY | Kevin | 29/10/21 |
| SCALE | 1:1 | |
| WEIGHT | 0.571kg | |

BIL Group Ltd, Porte Marsh Road, Calne
Wiltshire, SN11 9BW, United Kingdom
Tel +44 (0)1249 822 222 Fax: +44 (0)1249 822 300
www.bilgroup.co.uk

| | | | |
|-----------------|-----------------|--------------|---|
| DWG NO. | BZH8580WNYBJM20 | REV | 1 |
| BZH8580WNYBJM20 | | SHEET 1 OF 1 | |