

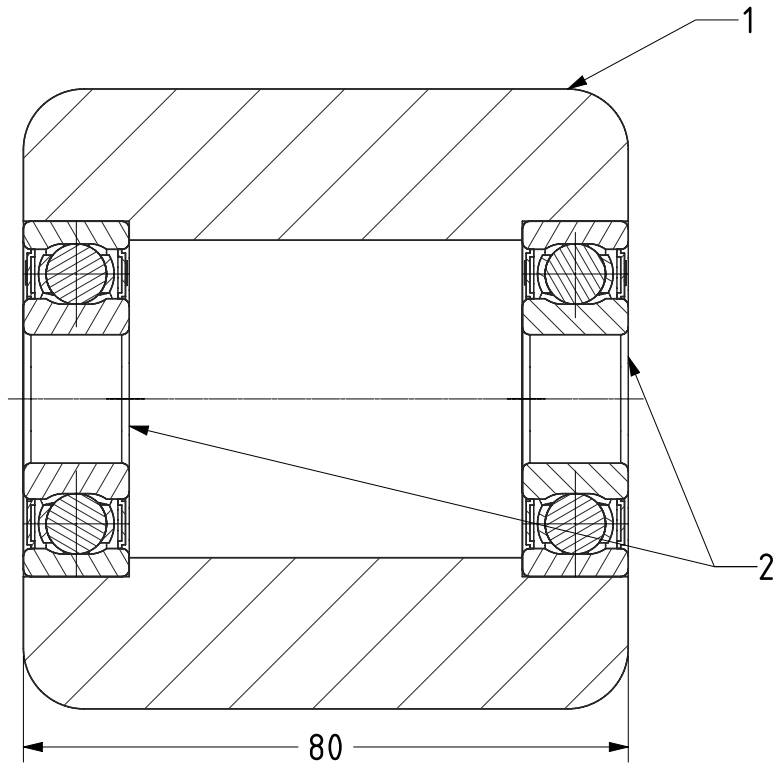

ITEM NO.	PART NUMBER	QTY
1	BZH8280WNYBJ	1
2	BEARING6303	2

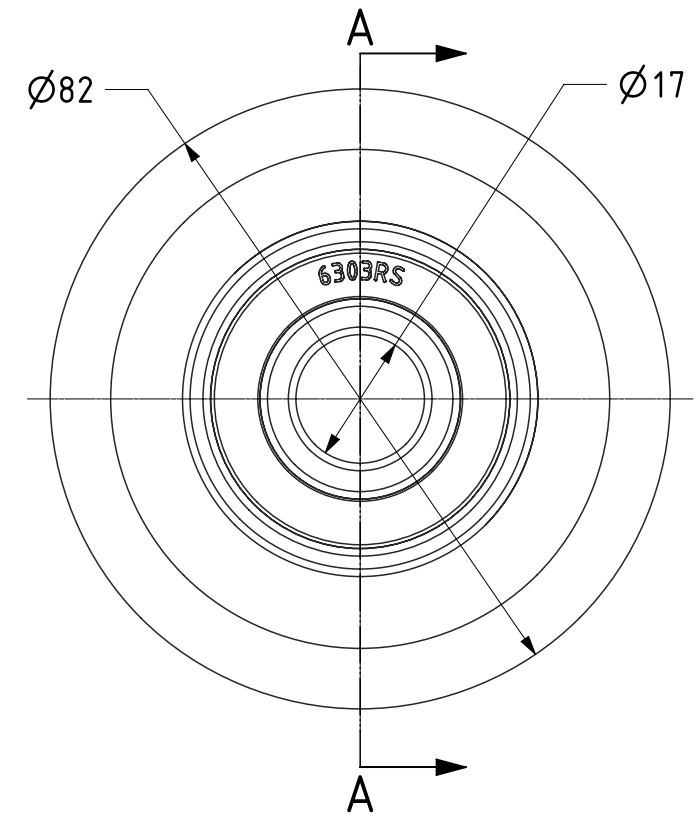

SECTION A-A



UNLESS OTHERWISE SPECIFIED DIMENSIONS ARE IN MILLIMETRES

Unspecified Tolerances
Machining $\pm 0.25\text{mm}$
Fabrication $\pm 1\text{mm}$

DRAWING DISCLAIMER

COPYRIGHT OF THIS DRAWING IS RESERVED BY BIL GROUP LTD. IT IS ISSUED ON CONDITION THAT IT IS NOT REPRODUCED, COPIED, OR DISCLOSED TO A THIRD PARTY EITHER WHOLLY OR IN PART WITHOUT THE CONSENT IN WRITING OF BIL GROUP LTD.

	NAME	DATE
DRAWN	Matt	28/10/21
APPROVED BY	Kevin	28/10/21
SCALE	1:1	
WEIGHT	0.551kg	



BIL Group Ltd, Porte Marsh Road, Calne
Wiltshire, SN11 9BW, United Kingdom
Tel +44 (0)1249 822 222 Fax: +44 (0)1249 822 300
www.bilgroup.co.uk

DWG NO.	BZH8280WNYBJM17	REV	1
BZH8280WNYBJM17		SHEET 1 OF 1	