

ITEM NO.	PART NUMBER	QTY
1	POLYURETHANE TYRE	1
2	NYLON RIM	1
3	ROLLER BEARING	1

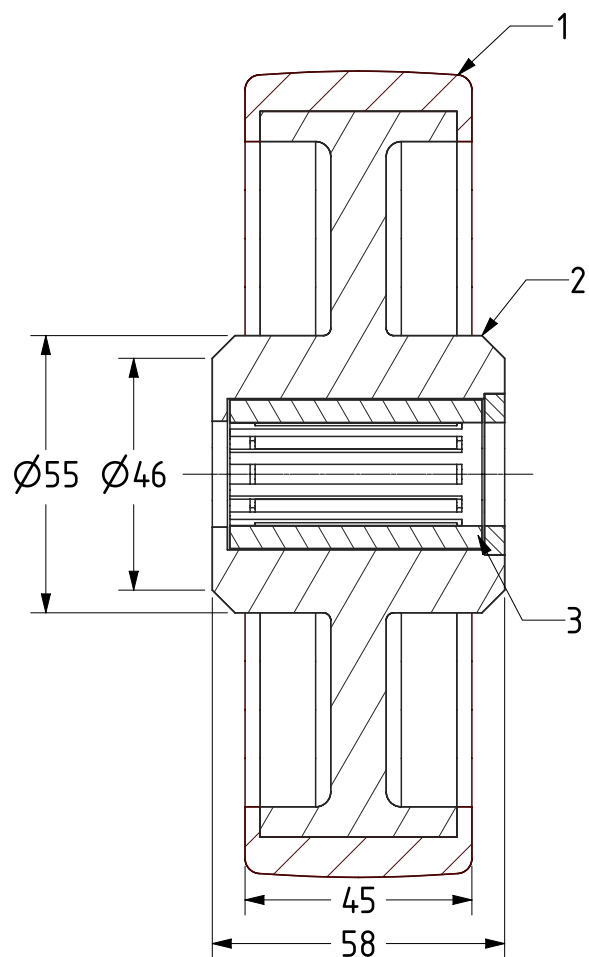

SECTION A-A

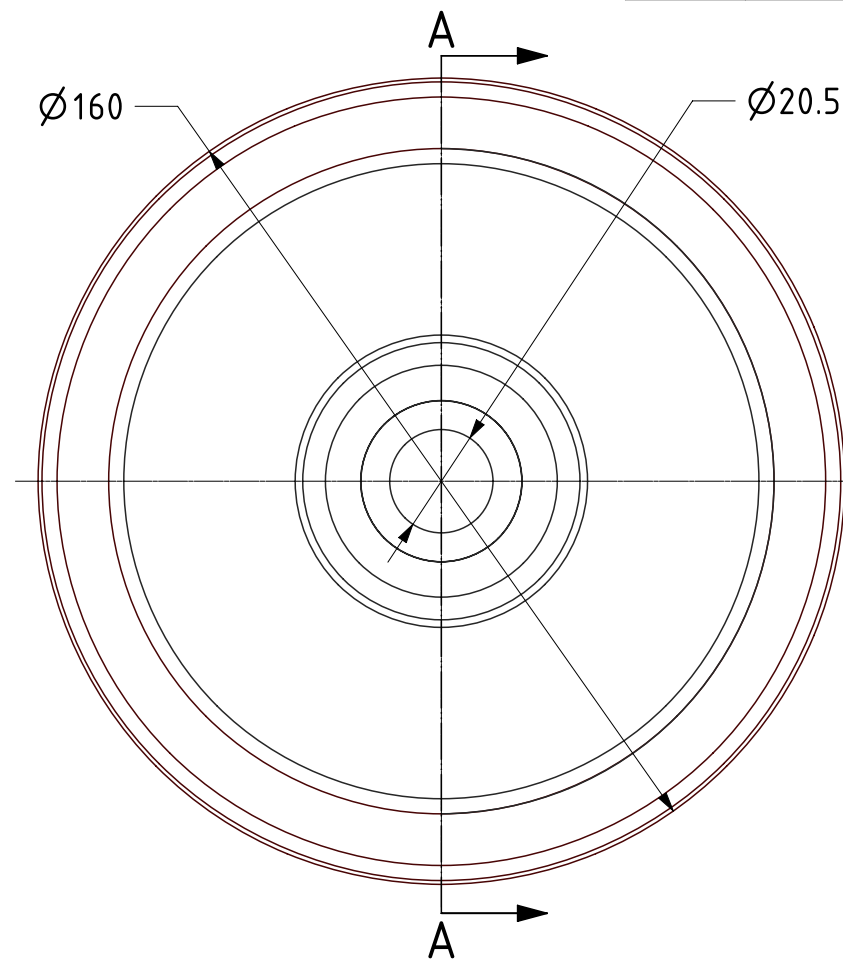

UNLESS OTHERWISE SPECIFIED DIMENSIONS ARE IN MILLIMETRES

Unspecified Tolerances
Machining $\pm 0.25\text{mm}$
Fabrication $\pm 1\text{mm}$

DRAWING DISCLAIMER

COPYRIGHT OF THIS DRAWING IS RESERVED BY BIL GROUP LTD. IT IS ISSUED ON CONDITION THAT IT IS NOT REPRODUCED, COPIED, OR DISCLOSED TO A THIRD PARTY EITHER WHOLLY OR IN PART WITHOUT THE CONSENT IN WRITING OF BIL GROUP LTD.

	NAME	DATE
DRAWN	Matt	20/01/22
APPROVED BY	Nathan	20/01/22
SCALE	2:3	
WEIGHT	0.656kg	

 BIL Group Ltd, Porte Marsh Road, Calne Wiltshire, SN11 9BW, United Kingdom Tel +44 (0)1249 822 222 Fax: +44 (0)1249 822 300 www.bilgroup.co.uk	DWG NO.	BZH160WPNRB	REV	1
	BZH160WPNRB		SHEET 1 OF 1	